

KSI ECOCLEAN® APF Compressed Air Filtration



Rev 01_0221

High performance filtration and separation for processing of compressed air and compressed gases in industrial supplier quality

החברה לטכנולוגיות אוויר דחוס בע"מ
מערכות ייבוש וסינון
מחוללי חמצן וחנקן
תכנון והקמה

PAT

שירותי מדחסים
לאוויר רפואי Medical
לאוויר למזון Food ותעשייה

טלפון: 09-7409913 פקס: 09-7469848
finish@pat-tech.co.il www.pat-tech.co.il

110
mbar

SMA, wet/saturated

APF / ADVANCED
PREMIUM
FILTRATION

High quality through manufacturer competence

KSI Filtertechnik produces **KSI ECOCLEAN®** compressed air filters and filter elements itself. This ensures complete control to ensure certified KSI industrial equipment quality. Our compressed air treatment components exceed customer expectations. Many years of continuous cooperation with specialists in the market, the compressed air trade and institutes, as well as our own intensive development work ensure this.

The KSI ECOCLEAN® approach

The combination of operational safety and economy in one product – this is the **KSI ECOCLEAN®** approach, perfectly implemented also for high-performance filter elements.

The KSI ECOCLEAN® APF | APE Plus-Effects +++

- + up to **55 %** less differential pressure loss
 - ▶ significantly reduced energy requirements and thus significantly reduced energy costs
- + **NEW:** high-density deep-bed pleating, made possible by new pleating machines, narrower pleating and new filter medium
 - ▶ approximately 250% larger filtration surface compared to a conventional pleated element
 - ▶ about 25% larger filtration surface compared to a conventional deep-bed pleated element

The significant reduction in flow velocity within the filtration medium makes the APF series the market leader in efficiency and lowest pressure drop.

KSI ECOCLEAN® APF

Compressed Air Filtration

APF / ADVANCED
PREMIUM
FILTRATION



High quality through manufacturer competence

The increasing demands of modern production processes also place ever higher demands on the quality of compressed air. Compressors compress the intake air, which contains substances harmful to production, many times over and usually release oils in the finest form as aerosols to the compressed air. In addition, impurities such as fine dust, oil droplets, rust particles, scale, parts of sealing material etc. from the compressed air network are added – and of course condensate (water). Filtration technology of the **KSI ECOCLEAN®** series protects pneumatic production plants, machines, tools, measuring instruments or products against contamination by means of high-performance filtration.

The heart of a compressed air filter is its filter insert (element), which must be optimally adapted to the respective requirement, as compressed air filters ensure, among other things, that solid particles, oil components, condensate, oil vapour, odours and much more are safely removed from the compressed air system.



An enormous service simplification: the internal condensate drain, which is inserted into the filter housing with the adapter.

The KSI ECOCLEAN® APF | APE Plus-Effects +++

- + highly efficient polyester drainage layer to improve performance and reduce differential pressure
 - ▶ anti-re-entry layer favors coalescence and drainage
- + cathodic dip coating (KTL) of the housing
 - ▶ prevents corrosion and thus offers optimum protection
- + housings made in aluminum die casting process
 - ▶ powerful and at the same time very light filter housing
 - ▶ easy handling during installation and service
- + element optimized in length and diameter
 - ▶ lowest differential pressures and best filtration and separation at full flow capacity
- + coloured end caps suitable for separation efficiency



The functional principle

Water separation

To ensure maximum compressed air quality, a water separator should be installed before using a compressed air filter. This separates condensate using a simple physical principle: centrifugal force.

The installation of a water separator not only increases the quality of the compressed air, but also the service life of the downstream filter elements.

Compressed air filtration

Due to the arc-shaped compressed air inlet, the flow through of the filter is optimal: the flow resistance is 75% lower. Filtration takes place through the various layers of the filter element, which is passed through from the inside to the outside, thus removing the unwanted components. After the compressed air filter, high-quality compressed air is now ready for further use.

Lowest Differential Pressure at highest capacity

Moisture, residual oil, particles: The performance of a compressed air system and the service life of the downstream components depend to a large extent on filtration. In recent years, we have continuously developed our **KSI ECOCLEAN®** filters and filter elements in our own well-equipped test centre (photo) in order to further increase performance, reliability and operational safety without affecting the favourable price.



Our KSI-owned test center provides us with all relevant data at the push of a button and offers the best conditions for product development.

110 mbar differential pressure thanks to high-density deep-bed pleating

Up to 55 % less differential pressure, significantly lower energy requirements and thus significantly reduced energy costs – these outstanding properties of the **KSI ECOCLEAN® APF** series are made possible by the high-density deep-bed pleating. Innovative pleating machines, tighter pleating and the new filter medium, in combination with the new filter housing, ensure that the flow rate within the filtration medium is reduced, making the APF series the market leader in efficiency and minimum pressure loss.

Differential pressure by comparison

SMA Submicrofilter (0,01 micron, 0,01 mg/m³)

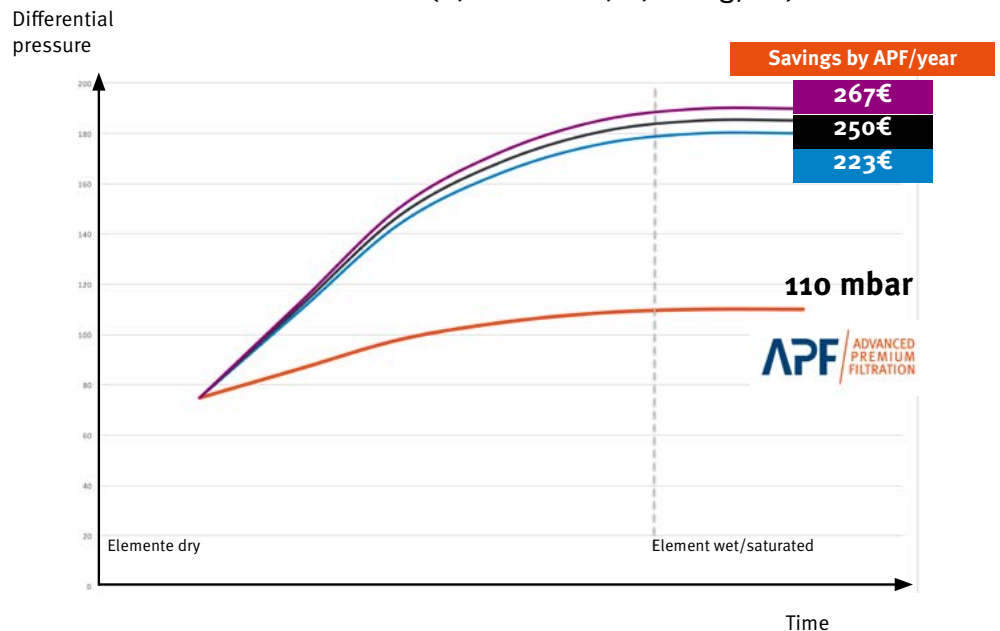

**What does the differential pressure loss cost?
 How much can I save if I minimize the pressure loss?**

SMA submicrofilter (0,01 micron, 0,01 mg/m³)

Calculation basis: 0,15 €/ kWh, 6000 operating hours p.a., compressor output 37 KW

Type	Differential pressure loss	Costs per year	Savings by APF per year
APF	270 mbar	899€	--
Filter purple	430 mbar	1.431€	532€
Filter black	475 mbar	1.581€	682€
Filter blue	460 mbar	1.531€	632€

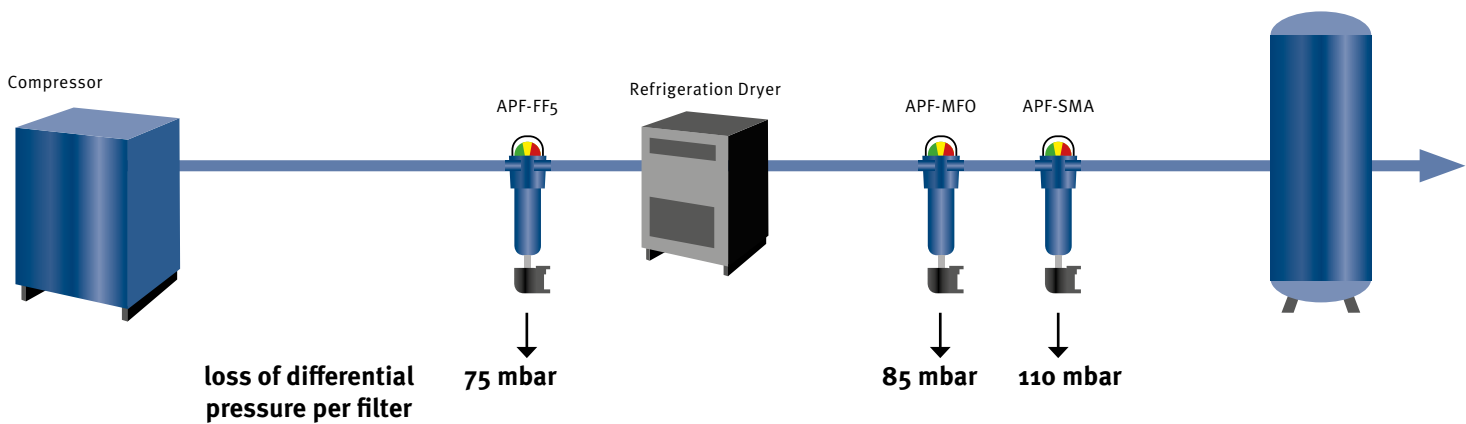

KSI ECOCLEAN® APF

Compressed Air Filtration

APF / ADVANCED
PREMIUM
FILTRATION



Highest quality standards for most economical company

KSI ECOCLEAN® compressed air filters meet the highest quality requirements and are extremely economical in operation, purchase and maintenance. The housing is made of die-cast aluminium, protected inside and outside with a cathodic dip coating (KTL) and powder-coated outside.

- + connections: 1/4" to 3"
- + output levels 35 m³/h - 2,200 m³/h
- + protects production & processes
 - ▶ extended machine & system service life
- + minimises operating costs ▶ saves energy
- + maximizes operational safety
 - ▶ protection against production or machine failure
- + best industrial equipment quality ▶ long service life
- + high service friendliness ▶ minimized service costs

Product range standard filtration

Threaded filter 15 types: APF23 with 35 m³/h and 1/4" connection up to APF193 with 2,200 m³/h and 3" connection

Flanged filter 7 types: FFo80-01 with 1,400 m³/h and DN80 connection up to FF200-09 with 12,600 m³/h and DN200 connection

Higher capacities available on request.

- + fast and safe installation ▶ fast commissioning
- + user-oriented filtration (25, 5, 1, 0.1 and 0.01 micron, as well as activated carbon) ▶ optimal selection
- + activated carbon, molecular sieve & hopkalite cartridges
 - ▶ individually combinable
- + best quality due to 100% leak test
- + **KSI ECOCLEAN®** filters are equipped with an automatic condensate drain

Further filter types:



Cartridge Filters
Activated carbon cartridge
Molecular sieve cartridge
Catalyst cartridge



Flanged Filters
up to 12.600 m³/h, DN 200
Flanged Water Separators
up to 8.400 m³/h, DN 150



Water Separators
up to 2.200 m³/h, 3"



High-Pressure Filters
50 bar – 450 bar



Medical Sterile Filters
Up to 1.500m³/h, 2 1/2"



Stainless Steel Filters
Sterile stainless steel filters and process filters



Vacuum Filters
Vacuum pump protection filters
Vacuum pump exhaust filters



Vacuum Filters
Medical vacuum filters

KSI ECOCLEAN® APF

Compressed Air Filtration

APF / ADVANCED PREMIUM FILTRATION



Operational safety and economic efficiency

The **KSI ECOCLEAN®** combines operational safety and economy in one product:

- through the constructive structure of the internal and external support frame up to 55% less differential pressure compared to conventional support cylinders
- maximum filter area due to the specially optimized pleating ► for maximum surface filtration
- special component adhesive securely fixes the end caps
- plastic end caps prevent blooming and bacterial growth
- filter drainage layer made of special fleece stabilizes the filter medium and protects against inflating effects and crack formation
- high-performance filter fleece is chemically, mechanically and thermal (up to 120° C) high load capacity and technically silicone-free
- filter depth volume enables highest dirt holding capacity capacity at maximum filtration performance

Compressed air quality with KSI ECOCLEAN® filter elements according to ISO 8573.1*

Element Typ	SMA					MF1					MFO					FF5					VF25					CA									
max. particle Ø [micron]	1					1					1					1					1					1									
Compr. air class	5	4	3	2	1	5	4	3	2	1	5	4	3	2	1	5	4	3	2	1	5	4	3	2	1	5	4	3	2	1	5	4	3	2	1
max. residual oil content	1					1					1					1					1														

*KSI ECOCLEAN® high performance filter elements exceed ISO 8573.1 by far.



Element SMA



APF-high performance element: high-density deep-bed pleating

For KSI filter housings:

- CAK activated carbon cartridge
- MSK molecular sieve cartridge
- HC catalyst cartridge

KSI ECOCLEAN® APF

Compressed Air Filtration

APF / ADVANCED PREMIUM FILTRATION



Scope of supply

Compressed air filter including:

KSI ECOCLEAN® Filter housing incl. filter element

D150 Automatic condensate drain for APF23 - APF133

D200 Automatic condensate drain for APF143 - APF193

Austauschelement | Replacement element

Typ	Leistung*		Abmessungen (mm)				Anschluss	Prod.
Type	Capacity*		Dimensions (mm)				Connection	Grp.
	m³/h	cfm	A	B	C	D		
APF23▶	35	21	234	18	80	75	1/4"	010
APF53▶	60	35	234	18	80	75	3/8"	010
APF63▶	60	35	234	18	80	75	1/2"	010
APF73▶	90	53	234	18	80	75	1/2"	010
APF79▶	120	71	328	23	104	98	1/2"	010
APF83▶	120	71	328	23	104	98	3/4"	010
APF93▶	220	129	328	23	104	98	3/4"	010
APF103▶	220	129	328	23	104	98	1"	010
APF113▶	360	212	612	34	154	150	1"	010
APF129▶	540	318	612	34	154	150	1 1/4"	010
APF133▶	700	412	612	34	154	150	1 1/2"	010
APF143▶	800	471	744	45	196	195	2"	010
APF163▶	1300	765	744	45	196	195	2"	010
APF173▶	1500	883	732	56	215	210	2 1/2"	010
APF193▶	2200	1295	899	56	215	210	3"	010

Element	Anzahl	Prod.
Element	Quantity	Grp.
APE26▶	1	110
APE26▶	1	110
APE26▶	1	110
APE70▶	1	110
APE78▶	1	110
APE78▶	1	110
APE91▶	1	110
APE91▶	1	110
APE110▶	1	110
APE123▶	1	110
APE123▶	1	110
APE140▶	1	110
APE160▶	1	110
APE170▶	1	110
APE190▶	1	110

*bezogen auf 1 bar (abs.) und 20°C bei 7 bar ü Betriebsdruck | calculated at 1 bar (abs.) and 20°C at 7 bar g working pressure

▶ = Abscheidegrad | filtration grade

Beispiel Bestellnummer für APF73 mit 1 Mikron Abscheidung: APF73MFO | Example order code for APF73 with 1 micron efficiency: APF73MFO

With flanged connection:

Typ	Leistung*		Abmessungen (mm)					Anschluss	Prod.
Type	Capacity*		Dimensions (mm)					Connection	Grp.
	m³/h	cfm	A	B	C	D	E		
APFFo80-01▶	1400	824	872	116	360	285	510	DN 80	011
APFFo80-02▶	2800	1684	1152	177	550	405	510	DN 80	011
APFF100-02▶	2800	1684	1152	177	550	405	510	DN 100	011
APFF100-03▶	4200	2472	1152	177	550	405	510	DN 100	011
APFF150-04▶	5600	3296	1222	207	620	460	540	DN 150	011
APFF150-06▶	8400	4944	1317	223	680	580	626	DN 150	011
APFF200-08▶	11200	6592	1706	288	800	715	760	DN 200	011
APFF200-09▶	12600	7416	1706	288	800	715	760	DN 200	011

Element	Anzahl	Prod.
Element	Quantity	Grp.
APE8601▶	1	110
APE8601▶	2	110
APE8601▶	2	110
APE8601▶	3	110
APE8601▶	4	110
APE8601▶	6	110
APE8601▶	8	110
APE8601▶	9	110

*bezogen auf 1 bar (abs.) und 20°C bei 7 bar ü Betriebsdruck | calculated at 1 bar (abs.) and 20°C at 7 bar g working pressure

▶ = Abscheidegrad | filtration grade

Beispiel Bestellnummer für APFF150-04 mit 0,01 Mikron Abscheidung: APFF150-04SMA | Example order code for APFF150-04 with 0,01 micron efficiency: APFF150-04SMA

Weitere Anschlüsse und höhere Volumenströme auf Anfrage | Other connections and capacities on request

Correction factors

Working pressure	bar g	2	3	4	5	6	7	8	9	10	11	12	13	14	15	16
factor		0,38	0,50	0,63	0,75	0,88	1,00	1,12	1,25	1,37	1,49	1,62	1,74	1,86	1,98	2,10





Multiplizieren Sie bitte die Leistung des Filters mit dem Korrekturfaktor in der oberen Tabelle. Beispiel: Leistung Typ APF79 bei 10 bar ü - Leistung nominal (120 m³/h) x Faktor (1,37) = Leistung korrigiert (164,4 m³/h).
Multiply the capacity of the filter by the correction factor in the table above. Example: Capacity Type APF79 at 10 bar g - capacity nominal (120 m³/h) x factor (1,37) = capacity corrected (164,4 m³/h).



KSI ECOCLEAN® APF

Compressed Air Filtration

APF / ADVANCED PREMIUM FILTRATION



Spezifikationen	 VF25	 FF5	 MFO	 MF1	 SMA	Specifications
Partikelfiltration	25 Mikron	5 Mikron	1 Mikron	0,1 Mikron	0,01 Mikron	Particle removal
Max. Restölgehalt bei 20°C	10 mg/m ³	5 mg/m ³	0,5 mg/m ³	0,1 mg/m ³	0,01 mg/m ³	Residual oil content at 20°C
Differenzdruck trocken*	45 mbar	50 mbar	55 mbar	65 mbar	75 mbar	Differential pressure dry*
Differenzdruck nass, gesättigt*	50 mbar	75 mbar	85 mbar	90 mbar	110 mbar	Diff. pressure wet, saturated*
Max. Arbeitsdruck	APF23 - APF163: 16 bar ü/g APF173: 13,5 bar ü/g APF193: 10,5 bar ü/g					Max. working pressure
Höchsttemperatur	Gehäuse Housings: 120°C · Elemente Elements: 120°C					Max. temperature
Tiefsttemperatur	1°C					Min. temperature
Material Gehäuse	Aluminium, KTL-Schutzschicht innen und außen Aluminum, inside and outside cathodic dip-paint coating (KTL)					Housing material
Farbausführung	blaue Pulverbeschichtung / RAL 5010 blue powder coated / RAL 5010					Colour

Spezifikationen	 DMF	 DF1	 DSF	Specifications
Partikelfiltration	1 Mikron	0,1 Mikron	0,01 Mikron	Particle removal
Differenzdruck*	55 mbar	65 mbar	75 mbar	Differential pressure*
Max. Arbeitsdruck	APF23 - APF163: 16 bar ü/g APF173: 13,5 bar ü/g APF193: 10,5 bar ü/g			Max. working pressure
Höchsttemperatur	Gehäuse Housings: 120°C · Elemente Elements: 120°C			Max. temperature
Tiefsttemperatur	1°C			Min. temperature
Material Gehäuse	Aluminium, KTL-Schutzschicht innen und außen Aluminum, inside and outside cathodic dip-paint coating (KTL)			Housing material
Farbausführung	blaue Pulverbeschichtung / RAL 5010 blue powder coated / RAL 5010			Colour

Spezifikationen	 CA	Specifications
Max. Restölgehalt bei 20°C	0,003 mg/m ³	Residual oil content at 20°C
Differenzdruck*	100 mbar	Differential pressure*
Max. Arbeitsdruck	APF23 - APF163: 16 bar ü/g APF173: 13,5 bar ü/g APF193: 10,5 bar ü/g	Max. working pressure
Höchsttemperatur	Gehäuse Housings: 120°C Elemente: 50°C; empfohlen: 25°C Elements: 50°C; recommended: 25°C	Max. temperature
Tiefsttemperatur	1°C	Min. temperature
Material Gehäuse	Aluminium, KTL-Schutzschicht innen und außen Aluminum, inside and outside cathodic dip-paint coating (KTL)	Housing material
Farbausführung	blaue Pulverbeschichtung / RAL 5010 blue powder coated / RAL 5010	Colour

*gilt nur bei Gewindefiltern | only valid for threaded filters



**Maßzeichnungen
 Dimensional Drawing**

FFo80-03 - FF200-09

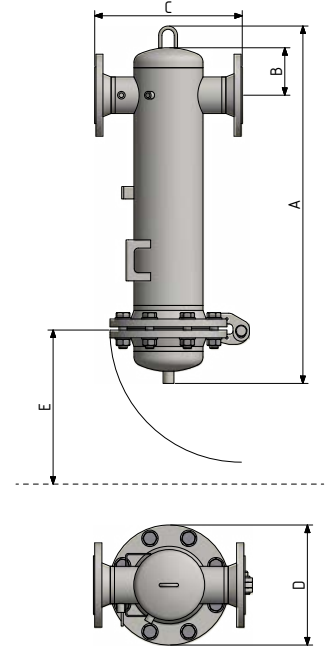
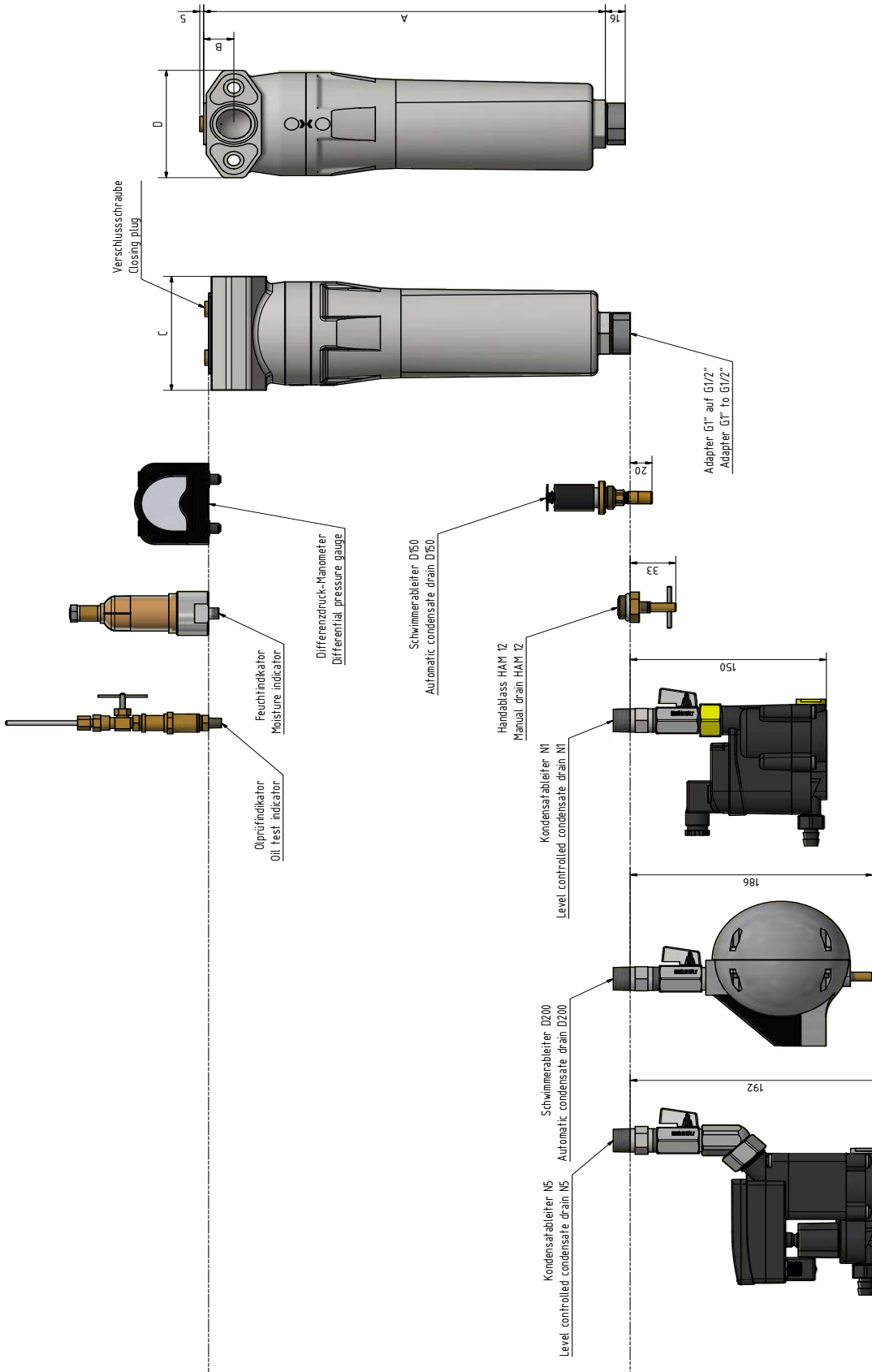

FFo80WS - FF150-WS

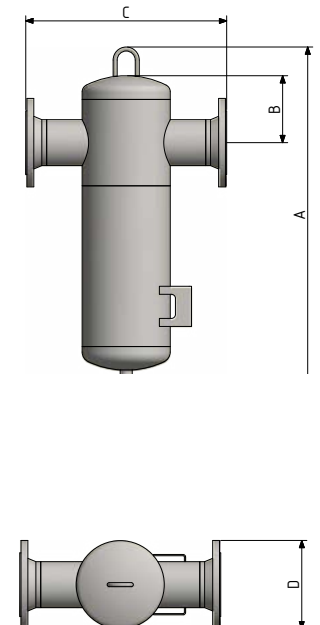

KSI ECOCLEAN® APF

Compressed Air Filtration

APF / ADVANCED
PREMIUM
FILTRATION



Approvals for pressure equipment

EU IV)	Approval for fluid group 2 according to Pressure Equipment Directive 2014/68/EU, module B+D (category
Other	ASME

Quality assurance

Development/production	DIN EN ISO 9001
------------------------	-----------------

Air purity class according to ISO 8573-1:2010

Solid particles	vary by filter element, see page 6
Moisture (gaseous)	vary by filter element, see page 6
Total oil	vary by filter element, see page 6

Options



Differential pressure indicator



Potential-free, digital
differential pressure manometer



Moisture indicator



Oil indicator



Filter connection set



Wall mounting incl.
filter connection set

Condensate drain



automatic drain D150,
standard for threaded filters
APF23 - APF133



automatic drain D200,
standard for threaded filters
APF143 - APF193 and all
flanged filters



level-controlled condensate
drain **KONDRAIN®** N1
(option for **KSI ECOCLEAN®**
standard filter)



manual drain HAM12,
standard in CA activated carbon
filters and in all cartridge filters